

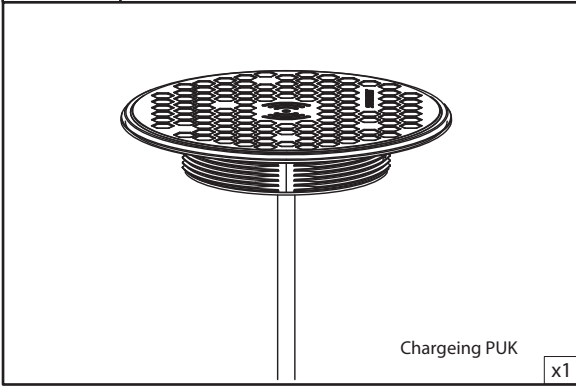

ROKK Wireless Charge Surface (SC-CW-02)

Installation Instructions
(Early Release)

Parts List

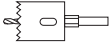

Tools Required

	<p>64/65mm (2.5") Hole Saw</p>
	<p>Power drill</p>
	<p>Alcohol Wipe</p>

1 Drill hole 64/65mm (2.5")

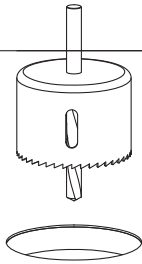

2 Remove Self-Adhesive backing.

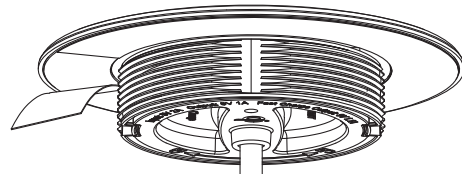

3 Ensure Surface is free from dirt or grease and insert into hole.

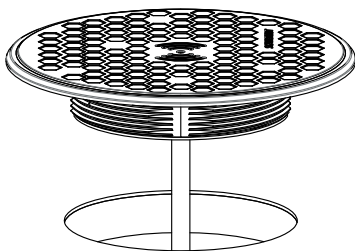

4 Connect wires to 12-24V supply, use solder tubes provided for a sealed joint.

